

1 2 3 4 5 6



A

B

C

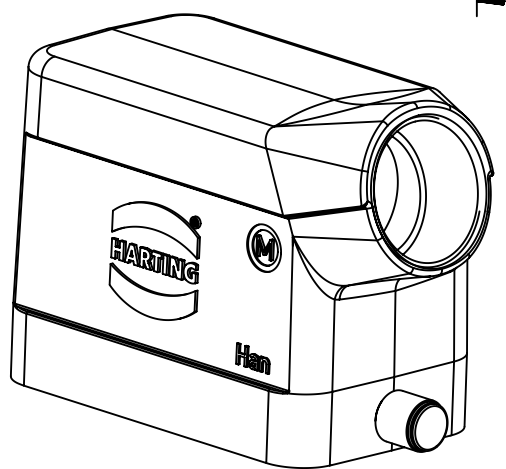
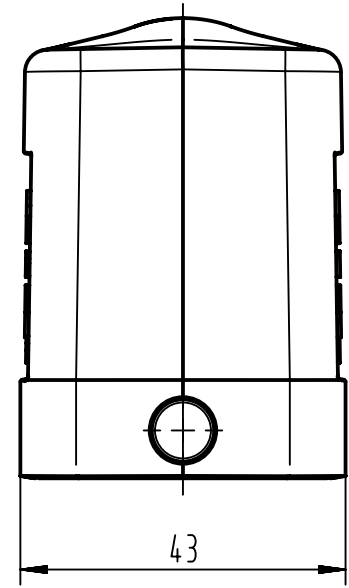
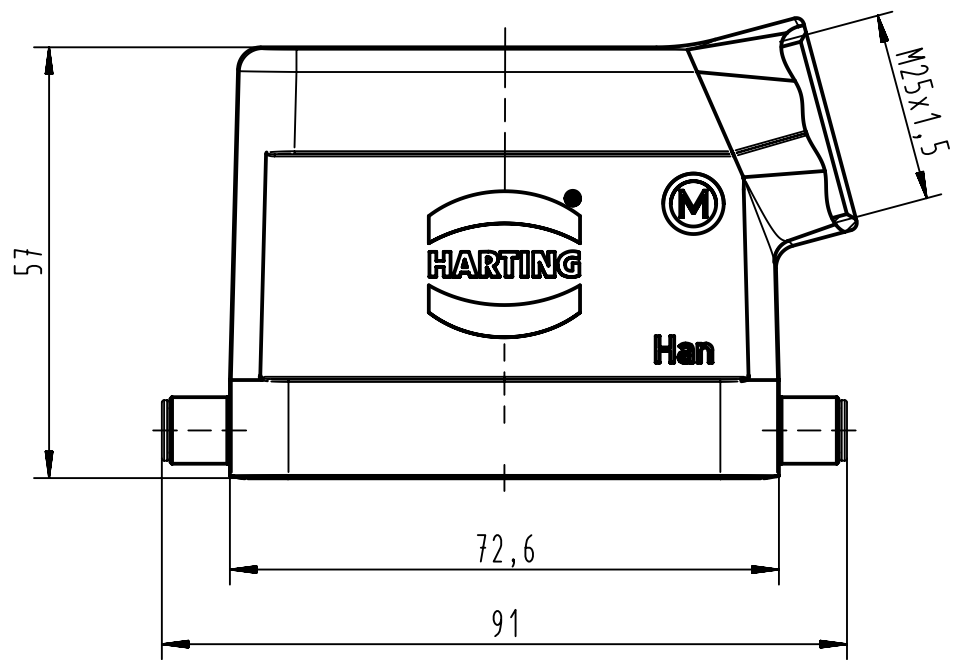
D

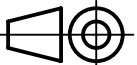

 All Dimensions in mm Original Size DIN A4	Scale 1:1		Free size tol.		Ref.
	Created by SCHULZI		Inspected by BERGHORN	Standardisation SCHMIDTM	Date 2013-01-17
 All rights reserved Department EL PD - DE	Title Han 10B-HMC-gs-R-M25				Doc-Key / ECM-Nr. 100520384/UGD/002/A
	HARTING Electric GmbH & Co. KG D-32339 Espelkamp		Type TB	Number 19 30 210 1541	