



Grayhill, Inc.

## 62S11-N5-080SH

Číslo dielu:

62S11-N5-080SH

Výrobca / Značka:

Grayhill, Inc.

Popis produktu

ROTARY ENCODER OPTICAL 32PPR

listoch:

 62S11-N5-080SH.pdf

Stav RoHS

 Bezolovnatý / V súlade RoHS

Stav zásob

1942 pcs stock

Odoslať z

Hong Kong

Cesta zásielky

DHL/Fedex/TNT/UPS/EMS

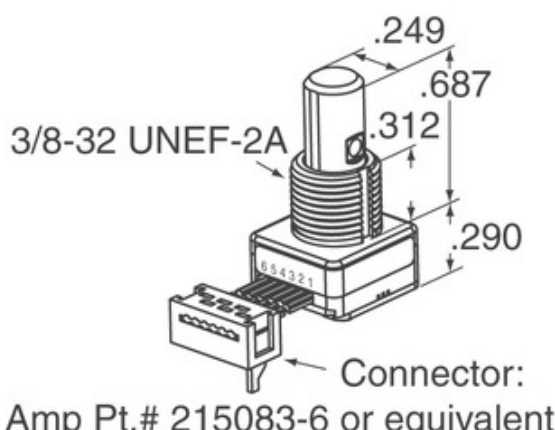

Connector:  
Amp Pt.# 215083-6 or equivalent

Obraz môže byť reprezentovaný. Pozrite si špecifikácie pre podrobnosti o produktoch.

[ŽIADOSŤ O CENOVÚ PONUKU](#)





### Špecifikácie 62S11-N5-080SH

ČÍSLO DIELU	62S11-N5-080SH
VÝROBCA	Grayhill, Inc.
POPIS	ROTARY ENCODER OPTICAL 32PPR
STAV VOL'NÉHO VODIČA / ROHS	Bezolovnatý / V súlade RoHS
DOSTUPNÉ MNOŽSTVO	1942 pcs
DÁTOVÝ HÁROK	 62S11-N5-080SH.pdf
NAPÄTIE - NAPÁJANIE	5V
STÝL UKONČENIA	Cable Leads
SÉRIA	62S
ROTAČNÁ ŽIVOTNOSŤ (CYKLY MIN)	1M
IMPULZY NA REVOLÚCIU	32
TYP VÝSTUPU	Quadrature (Incremental)
OSTATNÉ MENÁ	62S11N5080SH
ORIENTÁCIA	Vertical
TYP MONTÁŽE	Panel Mount
ÚROVEŇ CITLIVOSTI NA VLHKOSŤ (MSL)	1 (Unlimited)
STAV VOL'NÉHO VODIČA / ROHS	Lead free / RoHS Compliant
TYP KÓDOVAČA	Optical
ARETÁCIA	No
ZABUDOVANÝ PREPÍNAČ	Yes
TYP POHONU	1/4" Dia Flatted End

### Súvisiace značky

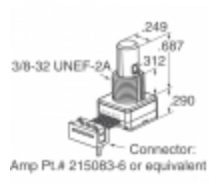
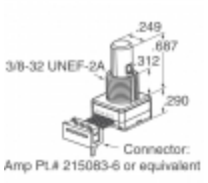
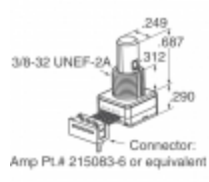
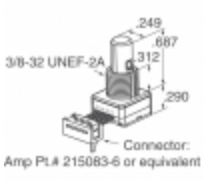
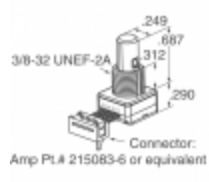
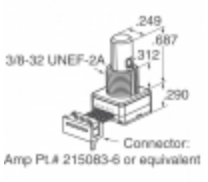
Grayhill, Inc. 62S11-N5-080SH	Distribútor 62S11-N5-080SH	Dodávateľ 62S11-N5-080SH
Cena 62S11-N5-080SH	Obrázky 62S11-N5-080SH	Obrázok 62S11-N5-080SH
62S11-N5-080SH PDF Datasheet	Stiahnuť dátový list 62S11-N5-080SH	Dátový list 62S11-N5-080SH
Zásoba 62S11-N5-080SH	Predám 62S11-N5-080SH	Predám Grayhill, Inc. 62S11-N5-080SH
Grayhill, Inc. 62S11-N5-080SH	Dodávateľ Grayhill, Inc.	Distribútor Grayhill, Inc.
Grayhill, Inc. 62S11-N5-080SH	Grayhill Inc. 62S11-N5-080SH	

### Súvisiace produkty

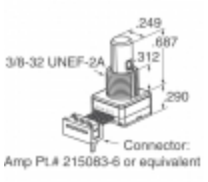
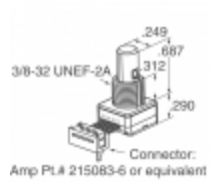
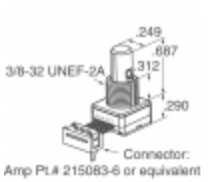
 <p><b>62S11-N5-060SH</b> výrobcovia: Grayhill, Inc. popis: ROTARY ENCODER OPTICAL 32PPR Skladom: 2263 pcs</p> <p><a href="#">RFQ</a></p>	 <p><b>62S11-N5-050C</b> výrobcovia: Grayhill, Inc. popis: ROTARY ENCODER OPTICAL 32PPR Skladom: 1936 pcs</p> <p><a href="#">RFQ</a></p>
 <p><b>62S11-N5-100C</b> výrobcovia: Grayhill, Inc. popis: ROTARY ENCODER OPTICAL 32PPR Skladom: 1789 pcs</p> <p><a href="#">RFQ</a></p>	 <p><b>62S11-N5-040C</b> výrobcovia: Grayhill, Inc. popis: ROTARY ENCODER OPTICAL 32PPR Skladom: 2106 pcs</p> <p><a href="#">RFQ</a></p>
 <p><b>62S11-N9-060C</b> výrobcovia: Grayhill, Inc. popis: ROTARY ENCODER OPTICAL 32PPR Skladom: 2192 pcs</p> <p><a href="#">RFQ</a></p>	 <p><b>62S11-N5-P</b> výrobcovia: Grayhill, Inc. popis: ROTARY ENCODER OPTICAL 32PPR Skladom: 1885 pcs</p> <p><a href="#">RFQ</a></p>
 <p><b>62S11-N5-PV</b> výrobcovia: Grayhill, Inc. popis: ROTARY ENCODER OPTICAL 32PPR Skladom: 2220 pcs</p> <p><a href="#">RFQ</a></p>	 <p><b>62S11-N5-025CH</b> výrobcovia: Grayhill, Inc. popis: ROTARY ENCODER OPTICAL 32PPR Skladom: 2083 pcs</p> <p><a href="#">RFQ</a></p>
 <p><b>62S11-N5-025C</b> výrobcovia: Grayhill, Inc. popis: ROTARY ENCODER OPTICAL 32PPR Skladom: 2408 pcs</p> <p><a href="#">RFQ</a></p>	 <p><b>62S11-N5-060C</b> výrobcovia: Grayhill, Inc. popis: ROTARY ENCODER OPTICAL 32PPR Skladom: 2164 pcs</p> <p><a href="#">RFQ</a></p>
 <p><b>62S11-N9-060SH</b> výrobcovia: Grayhill, Inc. popis: ROTARY ENCODER OPTICAL 32PPR Skladom: 1801 pcs</p> <p><a href="#">RFQ</a></p>	 <p><b>62S11-N5-120S</b> výrobcovia: Grayhill, Inc. popis: ROTARY ENCODER OPTICAL 32PPR Skladom: 1675 pcs</p> <p><a href="#">RFQ</a></p>

Copyright © 2020 Spoločnosť distribútor elektronických komponentov

E-mail: [Info@infinity-electronic.com](mailto:Info@infinity-electronic.com)

Adresa: 17F, Komerčná budova Gaylord, 114-118 Lockhart Road, Wan Chai, Hongkong

