



Grayhill, Inc.

## 62S11-H9-040C

Číslo dielu:

62S11-H9-040C

Výrobca / Značka:

Grayhill, Inc.

Popis produktu

ROTARY ENCODER OPTICAL 32PPR

listoch:

 62S11-H9-040C.pdf

Stav RoHS

 Bezolovnatý / V súlade RoHS

Stav zásob

1975 pcs stock

Odoslať z

Hong Kong

Cesta zásielky

DHL/Fedex/TNT/UPS/EMS

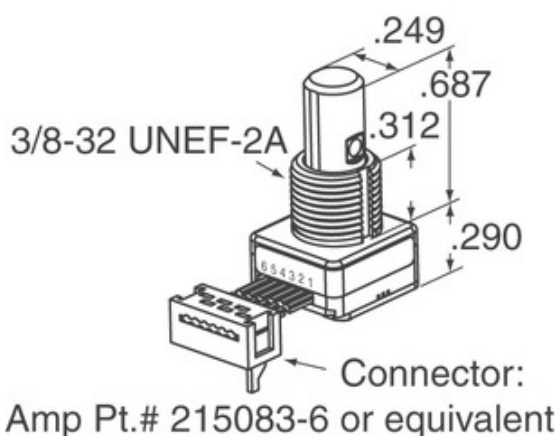

Obraz môže byť reprezentovaný. Pozrite si špecifikácie pre podrobnosti o produktoch.

[ŽIADOSŤ O CENOVÚ PONUKU](#)





### Špecifikácie 62S11-H9-040C

ČÍSLO DIELU	62S11-H9-040C
VÝROBCA	Grayhill, Inc.
POPIS	ROTARY ENCODER OPTICAL 32PPR
STAV VOL'NÉHO VODIČA / ROHS	Bezolovnatý / V súlade RoHS
DOSTUPNÉ MNOŽSTVO	1975 pcs
DÁTOVÝ HÁROK	 62S11-H9-040C.pdf
NAPÄTIE - NAPÁJANIE	5V
STÝL UKONČENIA	Cable with Connector
SÉRIA	62S
ROTAČNÁ ŽIVOTNOSŤ (CYKLY MIN)	1M
IMPULZY NA REVOLÚCIU	32
TYP VÝSTUPU	Quadrature (Incremental)
OSTATNÉ MENÁ	62S11H9040C
ORIENTÁCIA	Vertical
TYP MONTÁŽE	Panel Mount
ÚROVEŇ CITLIVOSTI NA VLHKOSŤ (MSL)	1 (Unlimited)
STAV VOL'NÉHO VODIČA / ROHS	Lead free / RoHS Compliant
TYP KÓDOVAČA	Optical
ARETÁCIA	Yes
ZABUDOVANÝ PREPÍNAČ	Yes
TYP POHONU	1/4" Dia Flatted End

### Súvisiace značky

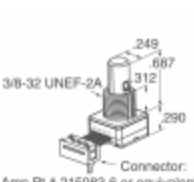
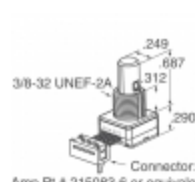
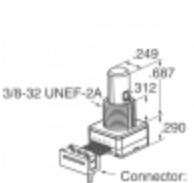
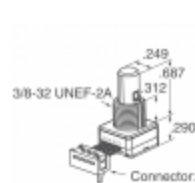
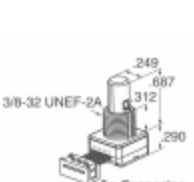
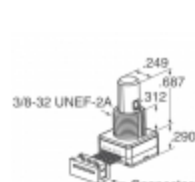
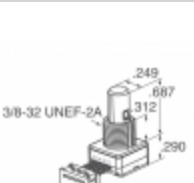
Grayhill, Inc. 62S11-H9-040C	Distribútor 62S11-H9-040C	Dodávateľ 62S11-H9-040C
Cena 62S11-H9-040C	Obrázky 62S11-H9-040C	Obrázok 62S11-H9-040C
62S11-H9-040C PDF Datasheet	Stiahnuť dátový list 62S11-H9-040C	Dátový list 62S11-H9-040C
Zásoba 62S11-H9-040C	Predám 62S11-H9-040C	Predám Grayhill, Inc. 62S11-H9-040C
Grayhill, Inc. 62S11-H9-040C	Dodávateľ Grayhill, Inc.	Distribútor Grayhill, Inc.
Grayhill, Inc. 62S11-H9-040C	Grayhill Inc. 62S11-H9-040C	

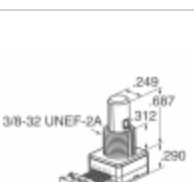
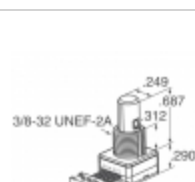
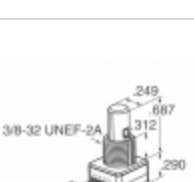
### Súvisiace produkty

 <p><b>62S11-H9-050S</b> výrobcovia: Grayhill, Inc. popis: ROTARY ENCODER OPTICAL 32PPR Skladom: 1839 pcs</p> <p><a href="#">RFQ</a></p>	 <p><b>62S11-H9-060SH</b> výrobcovia: Grayhill, Inc. popis: ROTARY ENCODER OPTICAL 32PPR Skladom: 1966 pcs</p> <p><a href="#">RFQ</a></p>
 <p><b>62S11-H9-025S</b> výrobcovia: Grayhill, Inc. popis: ROTARY ENCODER OPTICAL 32PPR Skladom: 2155 pcs</p> <p><a href="#">RFQ</a></p>	 <p><b>62S11-H9-040S</b> výrobcovia: Grayhill, Inc. popis: ROTARY ENCODER OPTICAL 32PPR Skladom: 2086 pcs</p> <p><a href="#">RFQ</a></p>
 <p><b>62S11-H9-P</b> výrobcovia: Grayhill, Inc. popis: ROTARY ENCODER OPTICAL 32PPR Skladom: 2159 pcs</p> <p><a href="#">RFQ</a></p>	 <p><b>62S11-H9-020C</b> výrobcovia: Grayhill, Inc. popis: ROTARY ENCODER OPTICAL 32PPR Skladom: 2176 pcs</p> <p><a href="#">RFQ</a></p>
 <p><b>62S11-H9-060C</b> výrobcovia: Grayhill, Inc. popis: ROTARY ENCODER OPTICAL 32PPR Skladom: 2172 pcs</p> <p><a href="#">RFQ</a></p>	 <p><b>62S11-H9-020S</b> výrobcovia: Grayhill, Inc. popis: ROTARY ENCODER OPTICAL 32PPR Skladom: 2170 pcs</p> <p><a href="#">RFQ</a></p>
 <p><b>62S11-H9-PH</b> výrobcovia: Grayhill, Inc. popis: ROTARY ENCODER OPTICAL 32PPR Skladom: 2090 pcs</p> <p><a href="#">RFQ</a></p>	 <p><b>62S11-H0-PH</b> výrobcovia: Grayhill, Inc. popis: ROTARY ENCODER OPTICAL 32PPR Skladom: 2006 pcs</p> <p><a href="#">RFQ</a></p>
 <p><b>62S11-H0-200S</b> výrobcovia: Grayhill, Inc. popis: ROTARY ENCODER OPTICAL 32PPR Skladom: 1933 pcs</p> <p><a href="#">RFQ</a></p>	 <p><b>62S11-H0-P</b> výrobcovia: Grayhill, Inc. popis: ROTARY ENCODER OPT 32PPR 10" CBL Skladom: 2508 pcs</p> <p><a href="#">RFQ</a></p>

Copyright © 2020 Spoločnosť distribútor elektronických komponentov

E-mail: [Info@infinity-electronic.com](mailto:Info@infinity-electronic.com)

Adresa: 17F, Komerčná budova Gaylord, 114-118 Lockhart Road, Wan Chai, Hongkong

