



Grayhill, Inc.

## 62S11-H0-060SH

Číslo dielu:

62S11-H0-060SH

Výrobca / Značka:

Grayhill, Inc.

Popis produktu

ROTARY ENCODER OPTICAL 32PPR

listoch:

 62S11-H0-060SH.pdf

Stav RoHS

 Bezolovnatý / V súlade RoHS

Stav zásob

2339 pcs stock

Odoslať z

Hong Kong

Cesta zásielky

DHL/Fedex/TNT/UPS/EMS

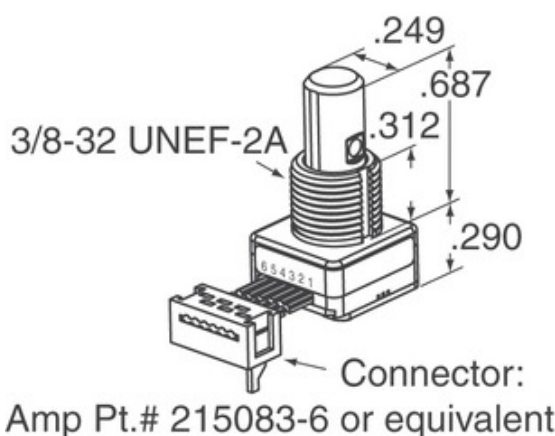

Obraz môže byť reprezentovaný. Pozrite si špecifikácie pre podrobnosti o produktoch.

[ŽIADOSŤ O CENOVÚ PONUKU](#)





### Špecifikácie 62S11-H0-060SH

ČÍSLO DIELU	62S11-H0-060SH
VÝROBCA	Grayhill, Inc.
POPIS	ROTARY ENCODER OPTICAL 32PPR
STAV VOL'NÉHO VODIČA / ROHS	Bezolovnatý / V súlade RoHS
DOSTUPNÉ MNOŽSTVO	2339 pcs
DÁTOVÝ HÁROK	 62S11-H0-060SH.pdf
NAPÄTIE - NAPÁJANIE	5V
STÝL UKONČENIA	Cable with Connector
SÉRIA	62S
ROTAČNÁ ŽIVOTNOSŤ (CYKLY MIN)	1M
IMPULZY NA REVOLÚCIU	32
TYP VÝSTUPU	Quadrature (Incremental)
OSTATNÉ MENÁ	62S11H0060SH
ORIENTÁCIA	Vertical
TYP MONTÁŽE	Panel Mount
ÚROVEŇ CITLIVOSTI NA VLHKOSŤ (MSL)	1 (Unlimited)
STAV VOL'NÉHO VODIČA / ROHS	Lead free / RoHS Compliant
TYP KÓDOVAČA	Optical
ARETÁCIA	Yes
ZABUDOVANÝ PREPÍNAČ	No
TYP POHONU	1/4" Dia Flatted End

### Súvisiace značky

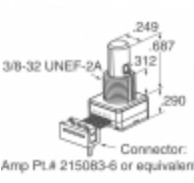
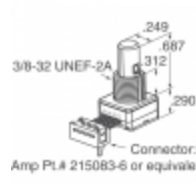
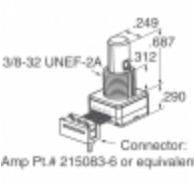
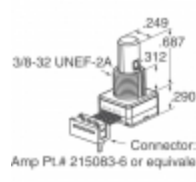
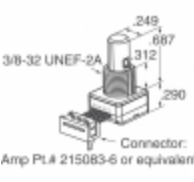
Grayhill, Inc. 62S11-H0-060SH	Distribútor 62S11-H0-060SH	Dodávateľ 62S11-H0-060SH
Cena 62S11-H0-060SH	Obrázky 62S11-H0-060SH	Obrázok 62S11-H0-060SH
62S11-H0-060SH PDF Datasheet	Stiahnuť dátový list 62S11-H0-060SH	Dátový list 62S11-H0-060SH
Zásoba 62S11-H0-060SH	Predám 62S11-H0-060SH	Predám Grayhill, Inc. 62S11-H0-060SH
Grayhill, Inc. 62S11-H0-060SH	Dodávateľ Grayhill, Inc.	Distribútor Grayhill, Inc.
Grayhill, Inc. 62S11-H0-060SH	Grayhill Inc. 62S11-H0-060SH	

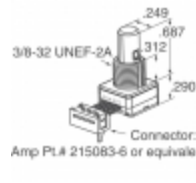
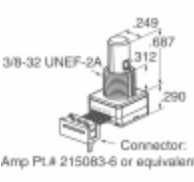
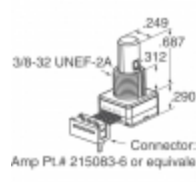
### Súvisiace produkty

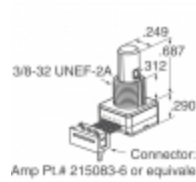
 <p><b>62S11-H0-060C</b> výrobcovia: Grayhill, Inc. popis: ROTARY ENCODER OPTICAL 32PPR Skladom: 2181 pcs</p> <p><a href="#">RFQ</a></p>	 <p><b>62S11-H0-200S</b> výrobcovia: Grayhill, Inc. popis: ROTARY ENCODER OPTICAL 32PPR Skladom: 1933 pcs</p> <p><a href="#">RFQ</a></p>
 <p><b>62S11-H9-025S</b> výrobcovia: Grayhill, Inc. popis: ROTARY ENCODER OPTICAL 32PPR Skladom: 2155 pcs</p> <p><a href="#">RFQ</a></p>	 <p><b>62S11-H9-020C</b> výrobcovia: Grayhill, Inc. popis: ROTARY ENCODER OPTICAL 32PPR Skladom: 2176 pcs</p> <p><a href="#">RFQ</a></p>
 <p><b>62S11-H0-PH</b> výrobcovia: Grayhill, Inc. popis: ROTARY ENCODER OPTICAL 32PPR Skladom: 2006 pcs</p> <p><a href="#">RFQ</a></p>	 <p><b>62S11-H0-040C</b> výrobcovia: Grayhill, Inc. popis: ROTARY ENCODER OPT 32PPR 2" CBL Skladom: 2505 pcs</p> <p><a href="#">RFQ</a></p>
 <p><b>62S11-H0-030C</b> výrobcovia: Grayhill, Inc. popis: ROTARY ENCODER OPT 32PPR 2" CBL Skladom: 2314 pcs</p> <p><a href="#">RFQ</a></p>	 <p><b>62S11-H9-020S</b> výrobcovia: Grayhill, Inc. popis: ROTARY ENCODER OPTICAL 32PPR Skladom: 2170 pcs</p> <p><a href="#">RFQ</a></p>
 <p><b>62S11-H0-020S</b> výrobcovia: Grayhill, Inc. popis: ROTARY ENCODER OPTICAL 32PPR Skladom: 1990 pcs</p> <p><a href="#">RFQ</a></p>	 <p><b>62S11-H9-040C</b> výrobcovia: Grayhill, Inc. popis: ROTARY ENCODER OPTICAL 32PPR Skladom: 1975 pcs</p> <p><a href="#">RFQ</a></p>
 <p><b>62S11-H0-P</b> výrobcovia: Grayhill, Inc. popis: ROTARY ENCODER OPT 32PPR 10" CBL Skladom: 2508 pcs</p> <p><a href="#">RFQ</a></p>	 <p><b>62S11-H0-020C</b> výrobcovia: Grayhill, Inc. popis: ROTARY ENCODER OPTICAL 32PPR Skladom: 2219 pcs</p> <p><a href="#">RFQ</a></p>

Copyright © 2020 Spoločnosť distribútor elektronických komponentov

E-mail: [Info@infinity-electronic.com](mailto:Info@infinity-electronic.com)

Adresa: 17F, Komerčná budova Gaylord, 114-118 Lockhart Road, Wan Chai, Hongkong

