



Grayhill, Inc.

62S11-L4-030S

Číslo dielu:

62S11-L4-030S

Výrobca / Značka:

Grayhill, Inc.

Popis produktu

ROTARY ENCODER OPTICAL 32PPR

listoch:

 62S11-L4-030S.pdf

Stav RoHS

 Bezolovnatý / V súlade RoHS

Stav zásob

1829 pcs stock

Odoslať z

Hong Kong

Cesta zásielky

DHL/Fedex/TNT/UPS/EMS

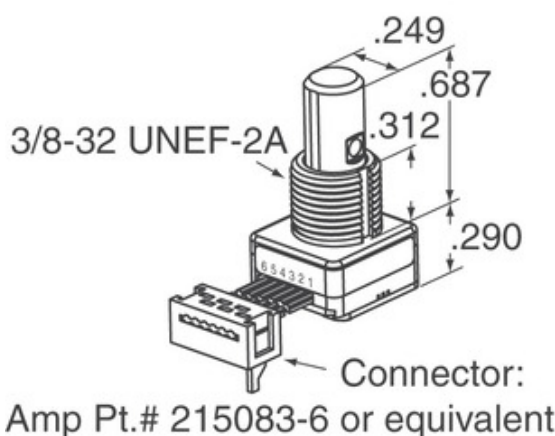

Obraz môže byť reprezentovaný. Pozrite si špecifikácie pre podrobnosti o produktoch.

[ŽIADOSŤ O CENOVÚ PONUKU](#)





Špecifikácie 62S11-L4-030S

ČÍSLO DIELU	62S11-L4-030S
VÝROBCA	Grayhill, Inc.
POPIS	ROTARY ENCODER OPTICAL 32PPR
STAV VOL'NÉHO VODIČA / ROHS	Bezolovnatý / V súlade RoHS
DOSTUPNÉ MNOŽSTVO	1829 pcs
DÁTOVÝ HÁROK	 62S11-L4-030S.pdf
NAPÄTIE - NAPÁJANIE	5V
STÝL UKONČENIA	Cable Leads
SÉRIA	62S
ROTAČNÁ ŽIVOTNOSŤ (CYKLY MIN)	1M
IMPULZY NA REVOLÚCIU	32
TYP VÝSTUPU	Quadrature (Incremental)
OSTATNÉ MENÁ	62S11L4030S
ORIENTÁCIA	Vertical
TYP MONTÁŽE	Panel Mount
ÚROVEŇ CITLIVOSTI NA VLHKOSŤ (MSL)	1 (Unlimited)
STAV VOL'NÉHO VODIČA / ROHS	Lead free / RoHS Compliant
TYP KÓDOVAČA	Optical
ARETÁCIA	Yes
ZABUDOVANÝ PREPÍNAČ	Yes
TYP POHONU	1/4" Dia Flatted End

Súvisiace značky

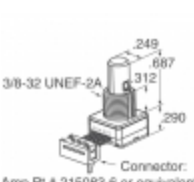
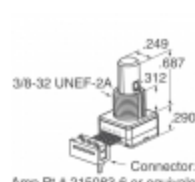
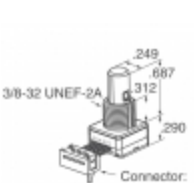
Grayhill, Inc. 62S11-L4-030S	Distribútor 62S11-L4-030S	Dodávateľ 62S11-L4-030S
Cena 62S11-L4-030S	Obrázky 62S11-L4-030S	Obrázok 62S11-L4-030S
62S11-L4-030S PDF Datasheet	Stiahnuť dátový list 62S11-L4-030S	Dátový list 62S11-L4-030S
Zásoba 62S11-L4-030S	Predám 62S11-L4-030S	Predám Grayhill, Inc. 62S11-L4-030S
Grayhill, Inc. 62S11-L4-030S	Dodávateľ Grayhill, Inc.	Distribútor Grayhill, Inc.
Grayhill, Inc. 62S11-L4-030S	Grayhill Inc. 62S11-L4-030S	

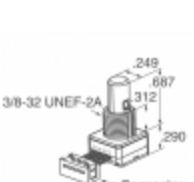
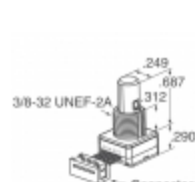
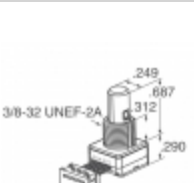
Súvisiace produkty

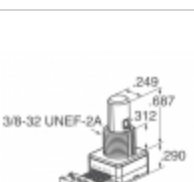
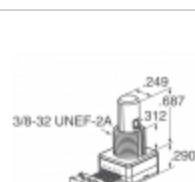
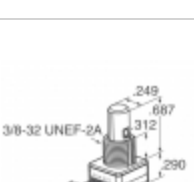
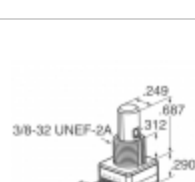
 <p>62S11-L0-PHV výrobcovia: Grayhill, Inc. popis: ROTARY ENCODER OPTICAL 32PPR Skladom: 1991 pcs</p> <p>RFQ</p>	 <p>62S11-L4-040CH výrobcovia: Grayhill, Inc. popis: ROTARY ENCODER OPTICAL 32PPR Skladom: 1716 pcs</p> <p>RFQ</p>
 <p>62S11-L4-040C výrobcovia: Grayhill, Inc. popis: ROTARY ENCODER OPTICAL 32PPR Skladom: 2290 pcs</p> <p>RFQ</p>	 <p>62S11-L4-050CH výrobcovia: Grayhill, Inc. popis: ROTARY ENCODER OPT 32PPR 4" CBL Skladom: 2019 pcs</p> <p>RFQ</p>
 <p>62S11-L4-080C výrobcovia: Grayhill, Inc. popis: ROTARY ENCODER OPTICAL 32PPR Skladom: 1843 pcs</p> <p>RFQ</p>	 <p>62S11-L4-020C výrobcovia: Grayhill, Inc. popis: ROTARY ENCODER OPTICAL 32PPR Skladom: 2162 pcs</p> <p>RFQ</p>
 <p>62S11-L4-020S výrobcovia: Grayhill, Inc. popis: ROTARY ENCODER OPT 32PPR 2" CBL Skladom: 1879 pcs</p> <p>RFQ</p>	 <p>62S11-L4-050C výrobcovia: Grayhill, Inc. popis: ROTARY ENCODER OPT 32PPR 4" CBL Skladom: 2211 pcs</p> <p>RFQ</p>
 <p>62S11-L0-P výrobcovia: Grayhill, Inc. popis: ROTARY ENCODER OPTICAL 32PPR Skladom: 2100 pcs</p> <p>RFQ</p>	 <p>62S11-L4-080CH výrobcovia: Grayhill, Inc. popis: ROTARY ENCODER OPTICAL 32PPR Skladom: 1886 pcs</p> <p>RFQ</p>
 <p>62S11-L4-025SH výrobcovia: Grayhill, Inc. popis: ROTARY ENCODER OPTICAL 32PPR Skladom: 2264 pcs</p> <p>RFQ</p>	 <p>62S11-L0-PH výrobcovia: Grayhill, Inc. popis: ROTARY ENCODER OPTICAL 32PPR Skladom: 2460 pcs</p> <p>RFQ</p>

Copyright © 2020 Spoločnosť distribútor elektronických komponentov

E-mail: Info@infinity-electronic.com

Adresa: 17F, Komerčná budova Gaylord, 114-118 Lockhart Road, Wan Chai, Hongkong

